

## INSPECTION AND MAINTENANCE LOG

MODEL NUMBER: \_\_\_\_\_

DATE OF MANUFACTURE: \_\_\_\_\_

Date	Part Number	Comments	Inspector Name

**Inspection:**  
Official periodic inspection must be made at least annually. The inspection must be performed by a qualified person other than the intended user. If severe weather or conditions exist then inspections must be carried out more frequently. All inspection results must be logged in the space provided above.

1. Inspect unit for visible signs of damage or wear that could affect operation. For example: kinked or frayed cables.
2. Make sure all labeling is affixed to the unit.
3. Check spoons and end termination operate smoothly with no metal burrs.
4. When reusing a previously drilled hole, inspect for debris or wallowing.
5. Record inspection results in the space provide above.

**\* If any damage that could affect the strength or operation of the device, or unsafe conditions are found, proper disposal is required. The anchorage connector must be rendered unusable and then properly discarded.**

### Product Warranty, Limited Remedy and Limitation of Liability

**WARRANTY: THE FOLLOWING IS MADE IN LIEU OF ALL WARRANTIES OR CONDITIONS, EXPRESS OR IMPLIED, INCLUDING THE IMPLIED WARRANTIES OR CONDITIONS OF MERCHANTABILITY OR FITNESS FOR A PARTICULAR PURPOSE.** Equipment offered by ClimbTech is warranted against factory defects in workmanship and materials for a period of one year from date of purchase.

**LIMITED REMEDY:** Upon notice in writing, ClimbTech will repair or replace all defective items at ClimbTech's sole discretion. ClimbTech reserves the right to require that the defective item be returned to its plant for inspection before determining the appropriate course of action. Warranty does not cover equipment damage resulting from wear, abuse, damage in transit, failure to maintain the product or other damage beyond the control of ClimbTech. ClimbTech shall be the sole judge of product condition and warranty options. This warranty applies only to original purchaser and is the only warranty applicable to this product. Please contact ClimbTech technical service department for assistance.

**LIMITATION OF LIABILITY: IN NO EVENT WILL CLIMBTECH BE LIABLE FOR ANY INDIRECT, INCIDENTAL, SPECIAL OR CONSEQUENTIAL DAMAGES INCLUDING, BUT NOT LIMITED TO, LOSS OF PROFITS, IN ANY WAY RELATED TO THE PRODUCTS REGARDLESS OF THE LEGAL THEORY ASSERTED.**



## Reusable Bolt Anchor 10,000-lbf / 44kN Model: RAF100N Assembled in USA

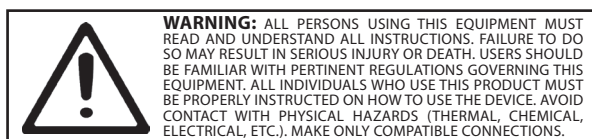
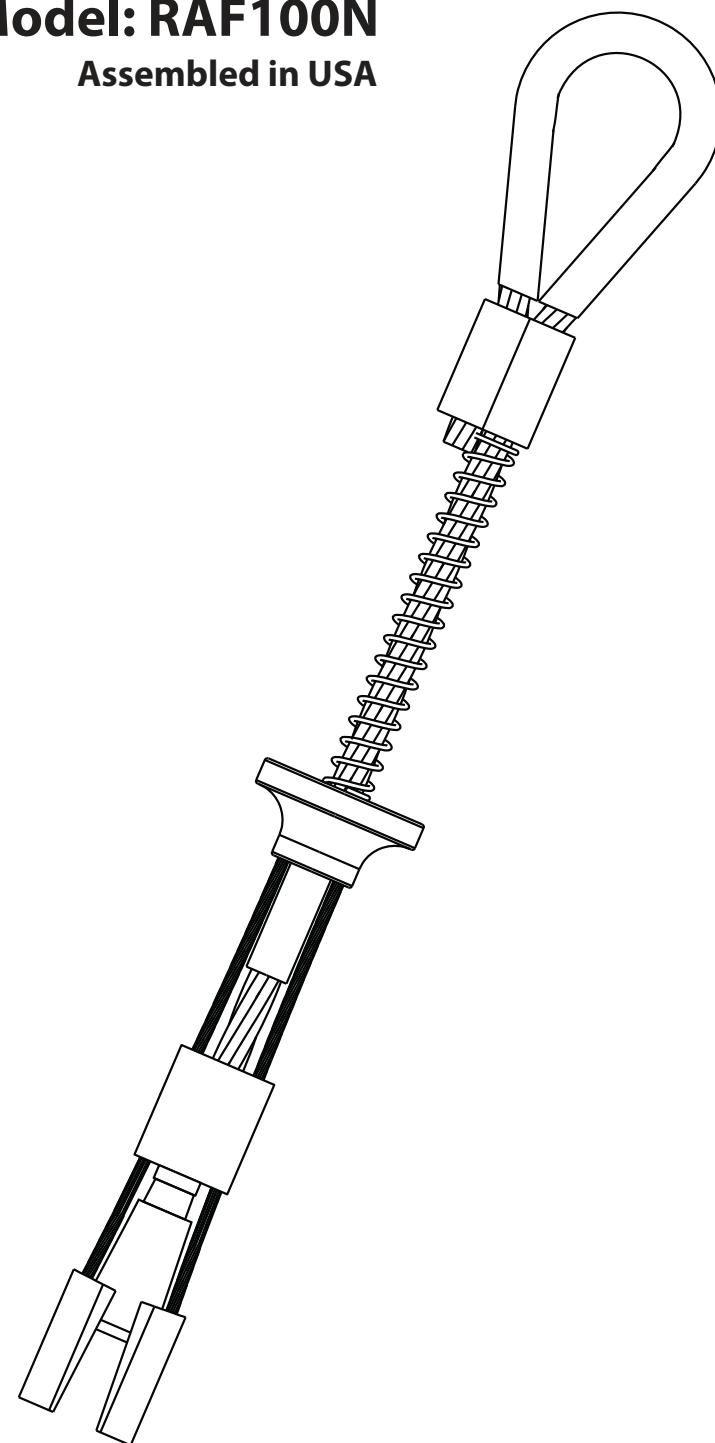

**WARNING:** ALL PERSONS USING THIS EQUIPMENT MUST READ AND UNDERSTAND ALL INSTRUCTIONS. FAILURE TO DO SO MAY RESULT IN SERIOUS INJURY OR DEATH. USERS SHOULD BE FAMILIAR WITH PERTINENT REGULATIONS GOVERNING THIS EQUIPMENT. ALL INDIVIDUALS WHO USE THIS PRODUCT MUST BE PROPERLY INSTRUCTED ON HOW TO USE THE DEVICE. AVOID CONTACT WITH PHYSICAL HAZARDS (THERMAL, CHEMICAL, ELECTRICAL, ETC.). MAKE ONLY COMPATIBLE CONNECTIONS.

Pat# US 7,357,363 B2 / US 7,011,281 B2 / US 6,729,821 B2

V3.0-A

## Read This Instruction Manual Carefully Before Using This Equipment.

User Instructions must always be available to the user and are not to be removed except by the user of this equipment. For proper use, see supervisor, User Instructions, or contact the manufacturer.



**WARNING**

Compliant fall protection and emergency rescue systems help prevent serious injury during fall arrest. Users and purchasers of this equipment must read and understand the User Instructions provided for correct use and care of this product. All users of this equipment must understand the instructions, operation, limitations and consequences of improper use of this equipment and be properly trained prior to use per OSHA 29 CFR 1910.66 and 1926.503 or applicable local standards.

**Misuse or failure to follow warnings and instructions may result in serious personal injury or death.**

### PURPOSE

The RAF100N is an anchorage connector designed to function as an interface between the anchorage and a fall protection, work positioning, rope access, or rescue system for the purpose of coupling the system to the anchorage. Any references to "anchorage connector" in this manual include, and apply to, the RAF100N.

### USE INSTRUCTIONS

1. A user must be of sound mind and body to properly and safely use this equipment in normal and emergency situations. Users must have a physician ensure they are clear of any medical conditions that may affect the proper and safe use of this equipment in normal and emergency situations.
2. Before using a personal fall arrest system, user must be trained in accordance with the requirements of OSHA 29 CFR 1910.66 in the safe use of the system and its components.
3. Use only with ANSI/OSHA compliant personal fall arrest or restraint systems. The anchorage must have the strength capable of supporting a static load, applied in the directions permitted by the system, of at least 10,000-lbf (44kN) in the absence of certification.
4. The user shall be equipped with a means of limiting the maximum dynamic forces exerted on the user during the arrest of a fall to a maximum of 8 kN (1800-lbf). In the EU these forces must be limited to 6 kN (1350-lbf)
5. Use of this product must be approved by an engineer or other qualified person to be compatible with any and all structural & operational characteristics of the selected installation location and system to be connected to this anchorage connector.
6. The anchorage connector must be inspected prior to each use for wear, damage, and other deterioration. If defective components are found, the anchorage connector must be immediately removed from service in accordance with the requirements of OSHA 29 CFR 1910.66 and 1926.502.
7. The anchorage connector should be positioned in such a way that minimizes the potential for falls and the potential fall distance during use. The complete fall protection system must be planned (including all components, calculating fall clearance, and swing fall) before using.
8. A rescue plan, and the means at hand to implement it, must be in place that provides the prompt rescue of users in the event of a fall, or assures that users are able to rescue themselves.
9. After a fall occurs the anchorage connector must be removed from service and destroyed immediately.

**USE LIMITATIONS: The anchorage connector shall not be used outside its limitations, or for any purpose other than that for which it is intended.**

1. The anchorage connector is designed for single user, with a capacity up to 310 lbs (140 kg) including clothing, tools, etc.
2. The anchorage connector may be pulled in any direction shown in the PROPER LOADING diagram.
3. The anchorage connector is designed to be used in temperatures ranging from -40°F to +130°F (-40°C to +54°C).
4. Do not expose the anchorage connector to chemicals or harsh solutions which may have a harmful effect.
5. Do not alter or modify this product in any way.
6. Caution must be taken when using any component of a fall protection, work positioning, rope access, or rescue system near moving machinery, electrical hazards, sharp edges, or abrasive surfaces, as contact may cause equipment failure, personal injury, or death.
7. Do not use/install equipment without proper training by a "competent person" as defined by OSHA 29 CFR 1926.32(f).
8. Do not remove the labeling from this product.
9. Additional requirements and limitations may apply depending on anchorage type and fastening option utilized for installation. All placements must be approved by an engineer or other qualified person.
10. This anchorage connector should not be used as part of a horizontal lifeline system that has not been designed and/or approved to be used with 10,000-lbf (44kN) anchorage connectors.
11. The anchorage connector should only be used for personal fall protection and not for lifting equipment.

### COMPATIBILITY LIMITATIONS

Anchorage connector must only be coupled to compatible connectors. OSHA 29 CFR 1926.502 prohibits snaphooks from being engaged to certain objects unless two requirements are met: it must be a locking type snaphook, and it must be "designed for" making such a connection. "Designed for" means that the manufacturer of the snaphook specifically designed the snaphook to be used to connect to the equipment listed. The following connections must be avoided, because they can result in rollout\* when a nonlocking snaphook is used:

- Direct connection of a snaphook to horizontal lifeline.
- Two (or more) snaphooks connected to one D-ring.
- Two snaphooks connected to each other.
- A snaphook connected back on its integral lanyard.
- A snaphook connected to a webbing loop or webbing lanyard.
- Improper dimensions of the D-ring, rebar, or other connection point in relation to the snaphook dimensions that would allow the snaphook keeper to be depressed by a turning motion of the snaphook.

**\*Rollout: A process by which a snaphook or carabiner unintentionally disengages from another connector or object to which it is coupled. (ANSI Z359.0-2007)**

### MAINTENANCE, CLEANING AND STORAGE

Cleaning periodically will prolong the life and proper functioning of the product. The frequency of cleaning should be determined by inspection and by severity of the environment. Clean with compressed air and/or a stiff brush using plain water or a mild soap and water solution. Do not use any corrosive chemicals that could damage the product. Wipe all surfaces with a clean, dry cloth and hang to dry, or use compressed air. When not in use, store anchorage connectors in a cool, dry, clean environment, out of direct sunlight and free of corrosive or other degrading elements.

ClimbTech, LLC.

7303 Bursleson Rd. Suite 901 Austin, TX 78744

1(512)308-6440 / www.climbtech.com

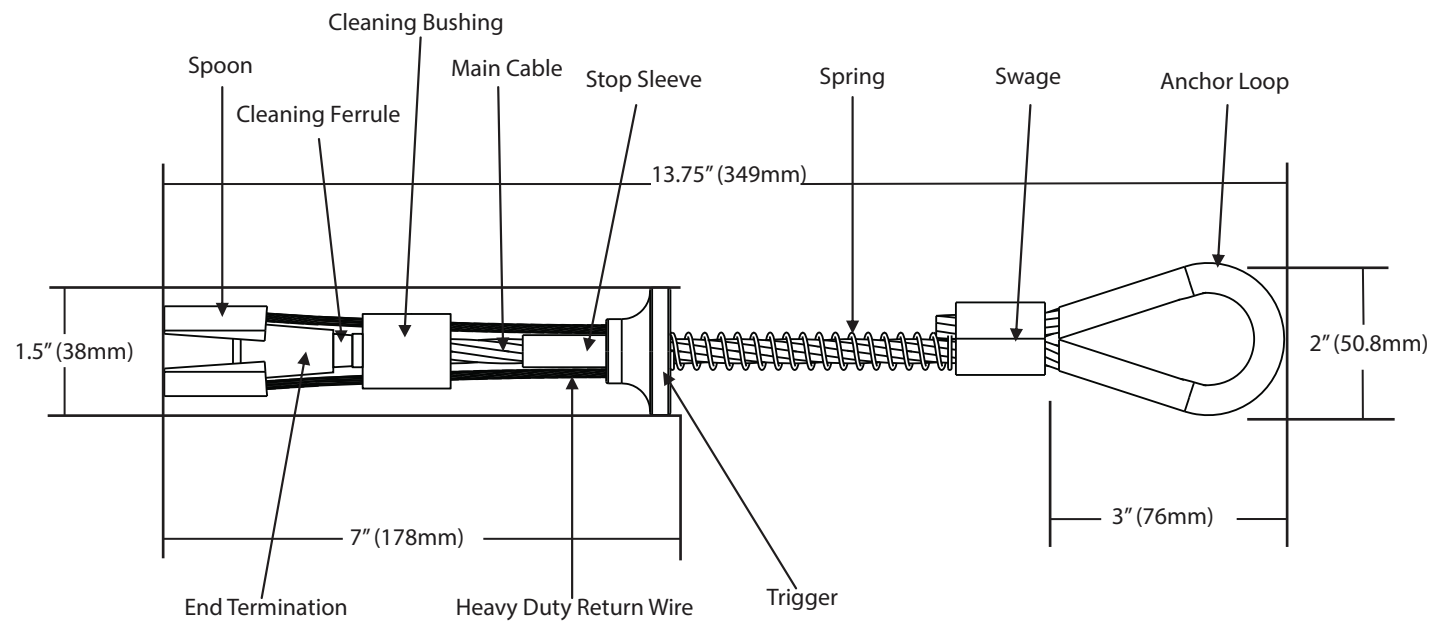

**PERFORMANCE:**

**Minimum Breaking Strength:** 10,000-lbf (44kN)

**Maximum Capacity:** One worker with max weight of 310-lbs (140kg) when used as a single point anchorage connector for personal fall arrest or restraint system

**DIMENSIONS:**

**Weight:** 1-lbs (453g)  
**Length:** 13.75" (349mm)  
**Diameter:** 1" (25mm)

**REGULATORY COMPLIANCE:**

ANSI Z359.18 Type A, ANSI Z359.7-2011  
 OSHA 1926.502, OSHA 1910.66,

**COMPONENT MATERIALS:**

**Aluminum:** Trigger  
**Aircraft Cable:** Main Cable, Activator Wire  
**Polyurethane:** Loop Cover  
**Stainless Steel:** Cone, Spoons, Stop Sleeve  
**Zinc Plated Steel:** Spring, Cleaning Bushing  
**Zinc Plated Copper:** Swage

**DRILLING & INSTALLATION INSTRUCTIONS:**

1. Drill a 1" (25mm) diameter hole at least 4.5" (114mm) deep. The drilled hole must be straight and perpendicular to the surface. Make sure the hole is of uniform diameter and free of peaks and valleys on the inner wall.
2. Blow hole clean with compressed air.
3. Always inspect the hole carefully when reusing a previously drilled hole.
4. When placing anchor, place your thumb inside the anchor loop and your first two fingers around the trigger. Squeeze fingers and thumb together till the trigger and spring fully compress.
5. Insert unit at least 4" (101mm) deep into hole and release the trigger. Do not force.
6. Set the unit with a slight tug on the anchor loop.
7. The stop sleeve must always be partially inserted into the hole.

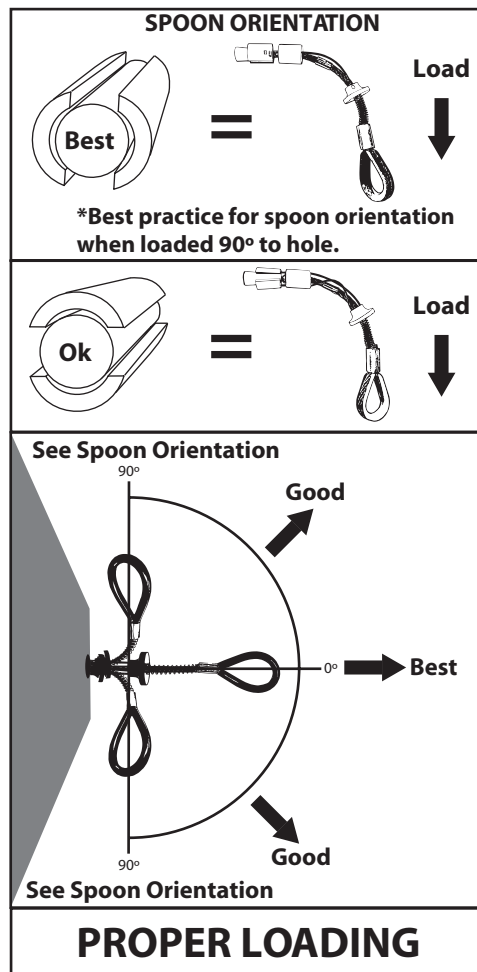
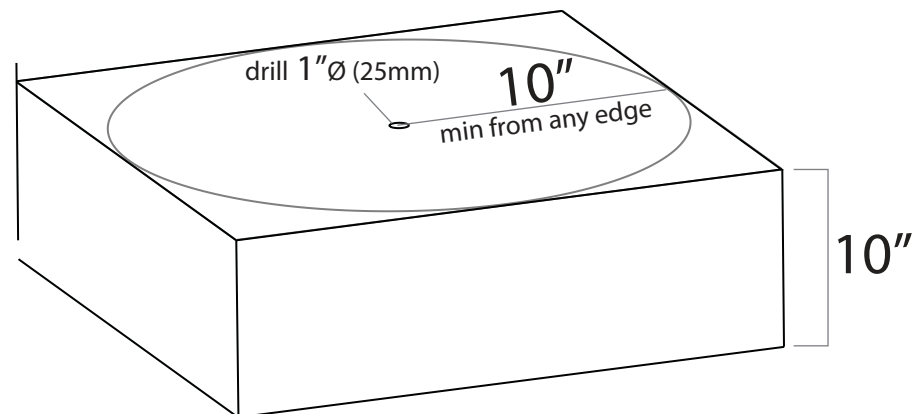

**REMOVAL INSTRUCTIONS:**

1. When removing anchor, place your thumb inside the anchor loop and your first two fingers around the trigger. Squeeze fingers and thumb together till the trigger and spring fully compress.
2. While squeezing the trigger pull the anchor out of the hole.
3. If the anchor becomes stuck, insert a punch, screwdriver or other object into the hole until it touches the top of the cleaning bushing.
4. Lightly tap with a hammer making sure the tool is touching the top of the cleaning bushing while squeezing the trigger (cleaning bushing should be easily visible at the edge of the hole).
5. If tool was required to remove the anchor, inspect thoroughly for damage after removal. If damage is found remove from service and destroy immediately.

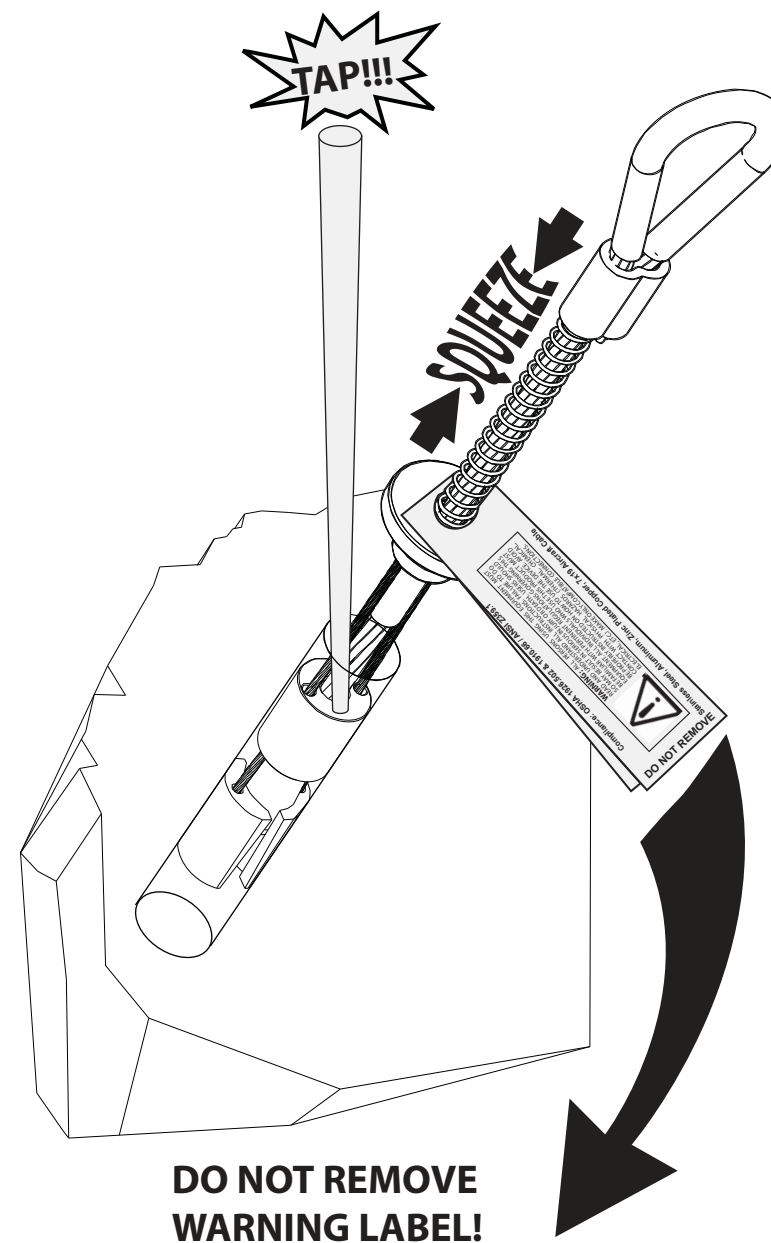

Compliance: OSHA 1926.502, OSHA 1910.66, ANSI Z359.18 Type A, ANSI Z359.7(11)  
 Max Capacity 310-lbs  
 10000lbs (22 kN) MBS  
 Removable Bolt  
 Right: XA  
 Left: XA  
 MFD: MM/YYYY  
 INSPECT BEFORE USE  
 CLIMBTECH  
 1-(512) 308-6440  
 Stainless Steel, Aluminum, Zinc Plated Copper, 7x19 Aircraft Cable  
 Part US 7.357.363 B2 / US 7.011.281 B2 / US 6.729.821 B2

May be used as an anchor point for a leading edge restraint system. See optional anchor points below for example. The use of two anchors is not required for leading edge restraint systems unless otherwise specified by the manufacturer.

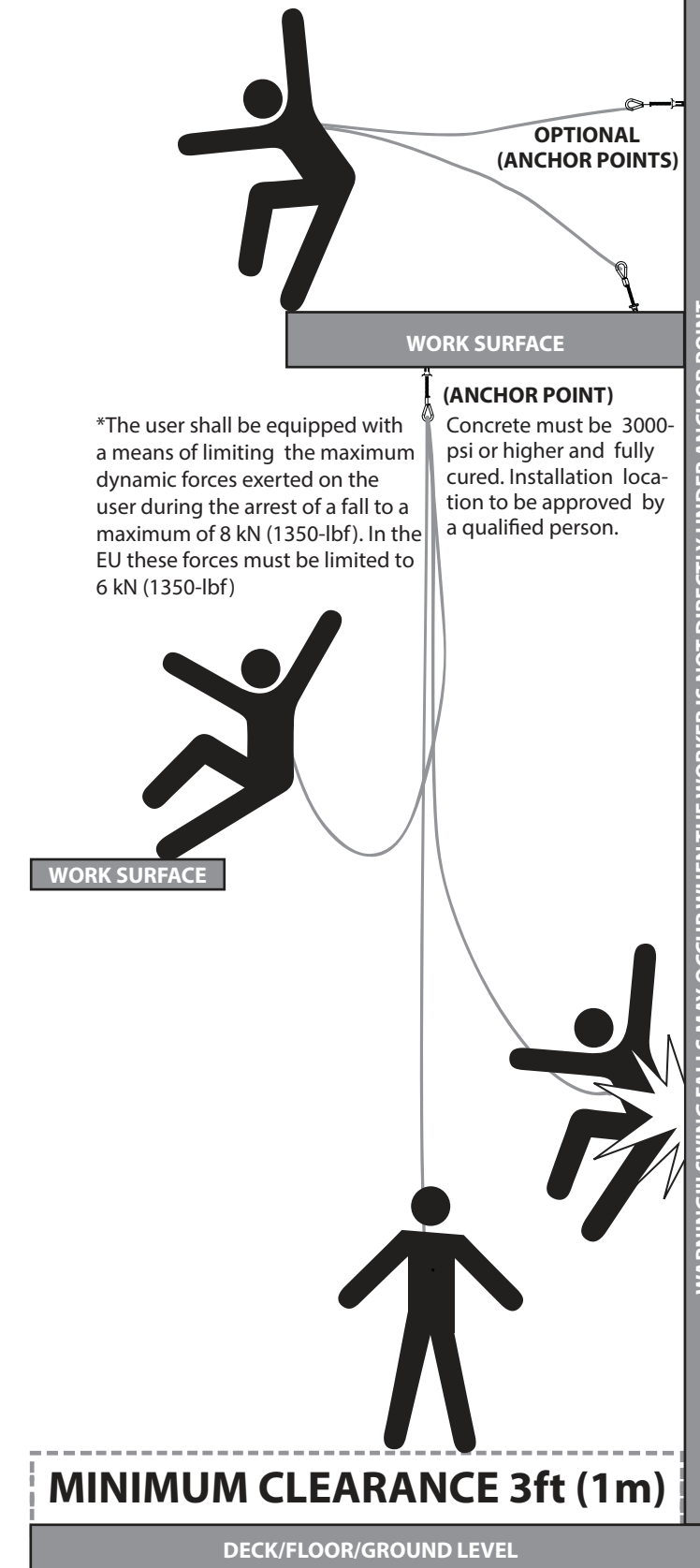

**MINIMUM CLEARANCE 3ft (1m)**  
 DECK/FLOOR/GROUND LEVEL

**All products subjected to fall arresting forces should be removed from service immediately!**

WARNING!! SWING FALLS MAY OCCUR WHEN THE WORKER IS NOT DIRECTLY UNDER ANCHOR POINT.