

(fig:1)

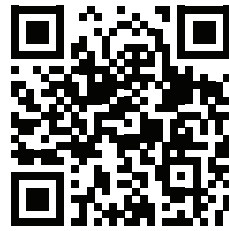

## See the 1/2" RB in action!

- New route setting.
- Alpine climbing.
- Belay anchor.
- Top roping.
- Haul lines.
- Search & rescue.
- Industrial

### Product Warranty, Limited Remedy and Limitation of Liability

**WARRANTY: THE FOLLOWING IS MADE IN LIEU OF ALL WARRANTIES OR CONDITIONS, EXPRESS OR IMPLIED, INCLUDING THE IMPLIED WARRANTIES OR CONDITIONS OF MERCHANTABILITY OR FITNESS FOR A PARTICULAR PURPOSE.** Equipment offered by ClimbTech is warranted against factory defects in workmanship and materials for a period of one year from date of purchase.

**LIMITED REMEDY:** Upon notice in writing, ClimbTech will repair or replace all defective items at ClimbTech's sole discretion. ClimbTech reserves the right to require that the defective item be returned to its plant for inspection before determining the appropriate course of action. Warranty does not cover equipment damage resulting from wear, abuse, damage in transit, failure to maintain the product or other damage beyond the control of ClimbTech. ClimbTech shall be the sole judge of product condition and warranty options. This warranty applies only to original purchaser and is the only warranty applicable to this product. Please contact ClimbTech technical service department for assistance.

**LIMITATION OF LIABILITY: IN NO EVENT WILL CLIMBTECH BE LIABLE FOR ANY INDIRECT, INCIDENTAL, SPECIAL OR CONSEQUENTIAL DAMAGES INCLUDING, BUT NOT LIMITED TO LOSS OF PROFITS, IN ANY WAY RELATED TO THE PRODUCTS REGARDLESS OF THE LEGAL THEORY ASSERTED.**

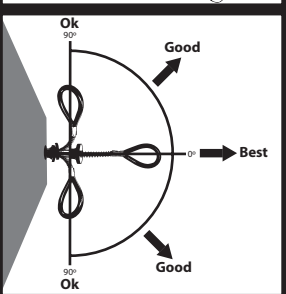
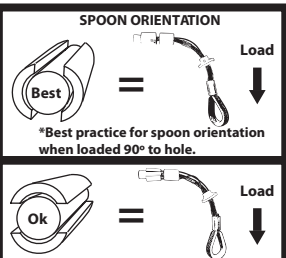

**PROPER LOADING**

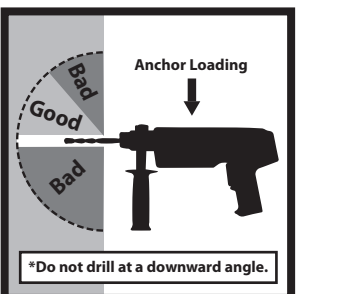
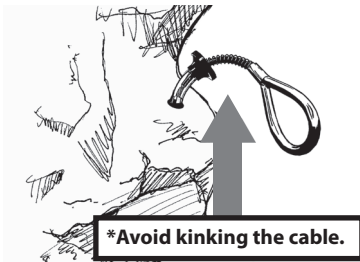

**PROPER DRILLING**



ClimbTech, LLC.  
 7303 Burselson Rd. Suite 901 Austin, TX 78744  
 1(512) 308-6440 / www.climbtech.com



**2500-lbf (11kN) Removable Bolt**  
**Model: RAF050N**

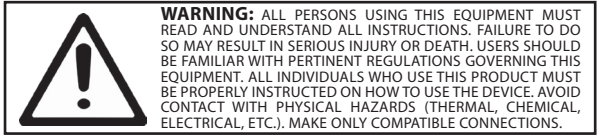

**WARNING:** ALL PERSONS USING THIS EQUIPMENT MUST READ AND UNDERSTAND ALL INSTRUCTIONS. FAILURE TO DO SO MAY RESULT IN SERIOUS INJURY OR DEATH. USERS SHOULD BE FAMILIAR WITH PERTINENT REGULATIONS GOVERNING THIS EQUIPMENT. ALL INDIVIDUALS WHO USE THIS PRODUCT MUST BE PROPERLY INSTRUCTED ON HOW TO USE THE DEVICE. AVOID CONTACT WITH PHYSICAL HAZARDS (THERMAL, CHEMICAL, ELECTRICAL, ETC.). MAKE ONLY COMPATIBLE CONNECTIONS.



2500-lbf (11kN) Removable Bolt

Model: RAF050N

### DRILLING & INSTALLATION INSTRUCTIONS:

1. Hole location should be chosen by a "competent person"
  2. Drill a 1/2" (12.7mm) diameter hole (see fig:1) at least 1.5" (38.1mm) deep. Make sure the hole is of uniform diameter and free of peaks and valleys on the inner wall.
  3. Thoroughly clear loose debris from hole. **(Always inspect the hole carefully when reusing a previously drilled hole.)**
  4. When placing the RB, place your thumb inside the anchor loop and your first two fingers around the trigger. Squeeze fingers and thumb together till the trigger and spring fully compress. (see fig:3)
  5. Insert RB at least 1.5" (38.1mm) deep into hole and release the trigger.
  6. Set the unit with a slight tug on the anchor loop.
- The cleaning bushing must always be fully inserted into the hole.** (see fig:2)

### REMOVAL INSTRUCTIONS:

1. When removing RB, place your thumb inside the anchor loop and your first two fingers around the trigger. Squeeze fingers and thumb together until the trigger and spring fully compress.
2. While squeezing the trigger pull the anchor out of the hole.
3. If the anchor becomes stuck, insert a punch, screwdriver or other object into the hole until it touches the top of the cleaning bushing. (see fig:3)
4. Lightly tap with a hammer making sure the tool is touching the top of the cleaning bushing until cone disengages from spoons. Repeat steps 1 and 2 to remove.
5. If tool was required to remove the anchor inspect thoroughly for damage after removal. If damage is found remove from service and destroy immediately.

### MAINTENANCE, CLEANING AND STORAGE

Cleaning periodically will prolong the life and proper functioning of the product. Clean with compressed air and/or a stiff brush using plain water or a mild soap and water solution. Do not use any corrosive chemicals that could damage the product. Wipe all surfaces with a clean dry cloth and hang to dry, or use compressed air. When not in use, store anchorage connectors in a cool, dry, clean environment, out of direct sunlight and free of corrosive or other degrading elements.

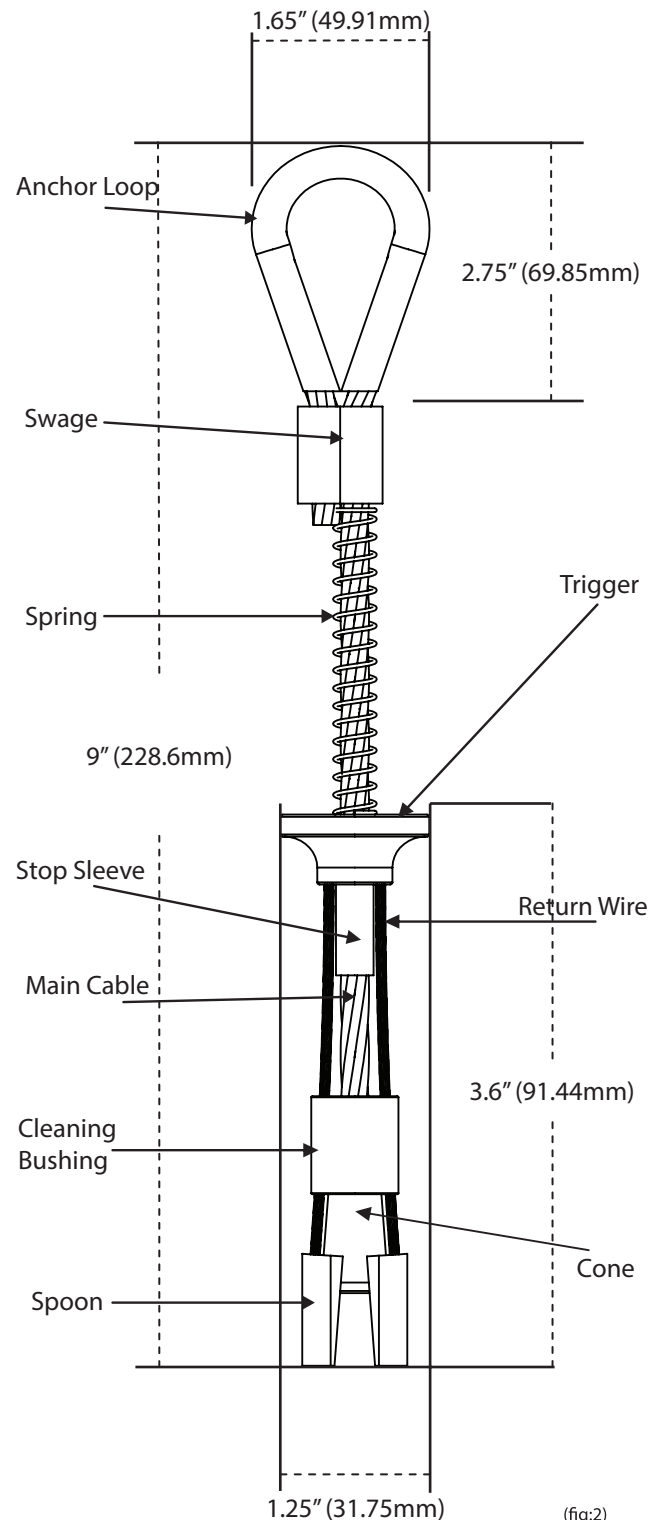

(fig:2)

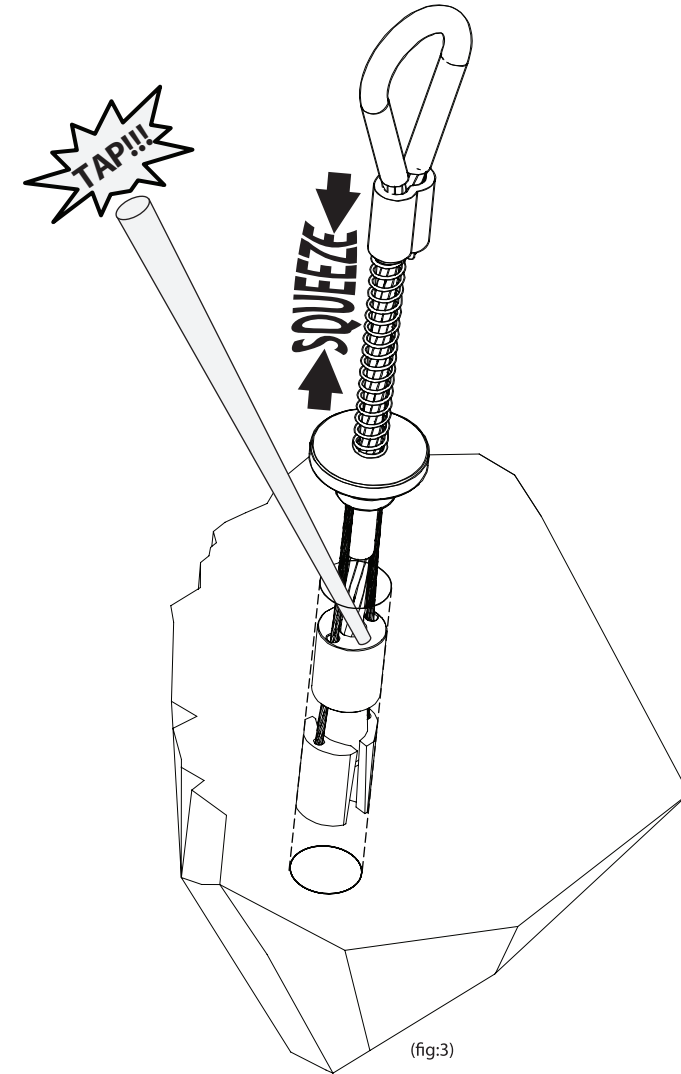

(fig:3)