

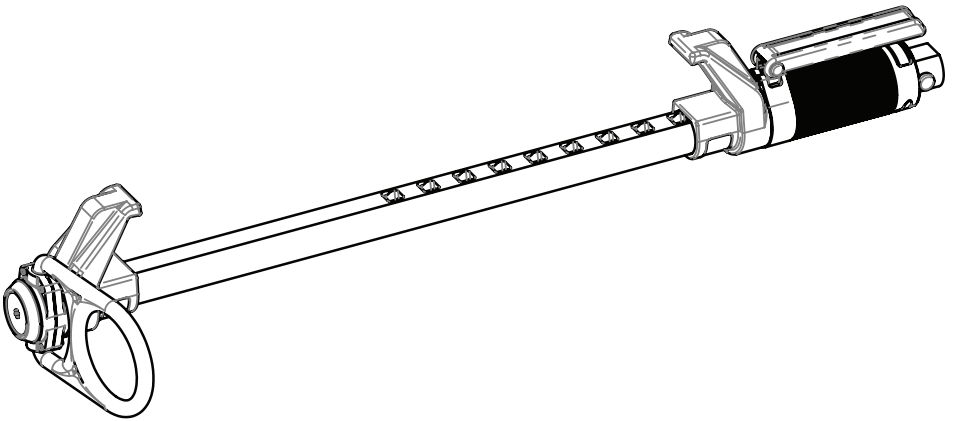

# CLIMBTECH



**VERTICAL / FIXED BEAM CLAMP  
I-BEAM ANCHOR  
ADJUSTABLE FROM 4"-14"  
Model # VBC014N**



**WARNING:** ALL PERSONS USING THIS EQUIPMENT MUST READ AND UNDERSTAND ALL INSTRUCTIONS. FAILURE TO DO SO MAY RESULT IN SERIOUS INJURY OR DEATH. USERS SHOULD BE FAMILIAR WITH PERTINENT REGULATIONS GOVERNING THIS EQUIPMENT. ALL INDIVIDUALS WHO USE THIS PRODUCT MUST BE PROPERLY INSTRUCTED ON HOW TO USE THE DEVICE. AVOID CONTACT WITH PHYSICAL HAZARDS (THERMAL, CHEMICAL, ELECTRICAL, ETC.). MAKE ONLY COMPATIBLE CONNECTIONS.

# Read This Instruction Manual Carefully Before Using This Equipment.

User Instructions must always be available to the user and are not to be removed except by the user of this equipment. For proper use, see supervisor, User Instructions, or contact the manufacturer.



## WARNING

Compliant fall protection and emergency rescue systems help prevent serious injury during fall arrest. Users and purchasers of this equipment must read and understand the User Instructions provided for correct use and care of this product. All users of this equipment must understand the instructions, operation, limitations and consequences of improper use of this equipment and be properly trained prior to use per OSHA 29 CFR 1910.66 and 1926.503 or applicable local standards.

**Misuse or failure to follow warnings and instructions may result in serious personal injury or death.**

### PURPOSE

The Vertical Beam Clamp is an anchorage connector designed to function as an interface between the anchorage and a fall protection, work positioning, rope access, or rescue system for the purpose of coupling the system to the anchorage. Any references to "anchorage connector" in this manual include, and apply to, the Vertical Beam Clamp.

### USE INSTRUCTIONS

1. A user must be of sound mind and body to properly and safely use this equipment in normal and emergency situations. Users must have a physician ensure they are clear of any medical conditions that may affect the proper and safe use of this equipment in normal and emergency situations.
2. Before using a personal fall arrest system, user must be trained in accordance with the requirements of OSHA 29 CFR 1910.66 as well as local regulations and requirements in the safe use of the system and its components.
3. Use only with ANSI/OSHA compliant personal fall arrest or restraint systems. The anchorage must have the strength capable of supporting a static load, applied in the directions permitted by the system, of at least 5,000-lbf (22kN) in the absence of certification.
4. The user shall be equipped with a means of limiting the maximum dynamic forces exerted on the user during the arrest of a fall to a maximum of 8 kN (1800-lbf). In the EU these forces must be limited to 6kN (1350-lbf).
5. Use of this product must be approved by an engineer or other qualified person to be compatible with any and all structural & operational characteristics of the selected installation location and system to be connected to this anchorage connector.
6. The anchorage connector must be inspected prior to each use for wear, damage, and other deterioration. If defective components are found the anchorage connector must be immediately removed from service in accordance with the requirements of OSHA 29 CFR 1910.66 and 1926.502.
7. The anchorage connector should be positioned in such a way that minimizes the potential for falls and the potential fall distance during use. The complete fall protection system must be planned (including all components, calculating fall clearance, and swing fall) before using.
8. A rescue plan, and the means at hand to implement it, must be in place that provides the prompt rescue of users in the event of a fall, or assures that users are able to rescue themselves.
9. After a fall occurs the anchorage connector must be removed from service and destroyed immediately.

**USE LIMITATIONS: The anchorage connector shall not be used outside its limitations, or for any purpose other than that for which it is intended.**

1. The anchorage connector is designed for single user, with a capacity up to 310 lbs (140 kg) including clothing, tools, etc.
2. The anchorage connector may only be loaded as shown in the LOADING CONDITIONS DIAGRAM.
3. The anchorage connector is designed to be used in temperatures ranging from -40°F to +130°F (-40°C to +54°C).
4. Do not expose the anchorage connector to chemicals or harsh solutions which may have a harmful effect.
5. Do not alter or modify this product in any way.
6. Caution must be taken when using any component of a fall protection, work positioning, rope access, or rescue system near moving machinery, electrical hazards, sharp edges, or abrasive surfaces, as contact may cause equipment failure, personal injury, or death.
7. Do not use/install equipment without proper training by a "competent person" as defined by OSHA 29 CFR 1926.32(f).
8. Do not remove the labeling from this product.
9. Additional requirements and limitations may apply depending on anchorage type and fastening option utilized for installation. All placements must be approved by an engineer or other qualified person.
10. This anchorage connector should not be used as part of a horizontal lifeline system that has not been designed and/or approved to be used with 5,000-lbf (22kn) anchorage connectors.
11. The anchorage connector should only be used for personal fall protection and not for lifting equipment.

### COMPATIBILITY LIMITATIONS

Anchorage connector must only be coupled to compatible connectors. OSHA 29 CFR 1926.502 prohibits snaphooks from being engaged to certain objects unless two requirements are met: it must be a locking type snaphook, and it must be "designed for" making such a connection. "Designed for" means that the manufacturer of the snaphook specifically designed the snaphook to be used to connect to the equipment listed. The following connections must be avoided, because they can result in rollout\* when a nonlocking snaphook is used:

- Direct connection of a snaphook to horizontal lifeline.
- Two (or more) snaphooks connected to one D-ring.
- Two snaphooks connected to each other.
- A snaphook connected back on its integral lanyard.
- A snaphook connected to a webbing loop or webbing lanyard.
- Improper dimensions of the D-ring, rebar, or other connection point in relation to the snaphook dimensions that would allow the snaphook keeper to be depressed by a turning motion of the snaphook.

**\*Rollout: A process by which a snaphook or carabiner unintentionally disengages from another connector or object to which it is coupled. (ANSI Z359.0-2007)**

**PERFORMANCE:**

**Minimum Breaking Strength (MBS)** 5000-lbf (22kN)

**Maximum Capacity:** One worker with max weight of 310-lbs (140 kg) when used as a single point anchorage connector for personal fall arrest or restraint system

**DIMENSIONS:**

**Weight:** 6.8-lbs (3kg)

**Beam Flange Width Range:** 4"-14" (10-35cm)

**Beam Flange Thickness:** .25" to 1.25" (7mm to 31mm)

**REGULATORY COMPLIANCE:**

ANSI Z359.18 Type A, ANSI Z359.7(11), OSHA 1926.502, OSHA 1910.66, EN 795:2012 Type B (CE 2777),

**COMPONENT MATERIALS:**

Zinc Plated Steel  
Stainless Steel  
Aluminum

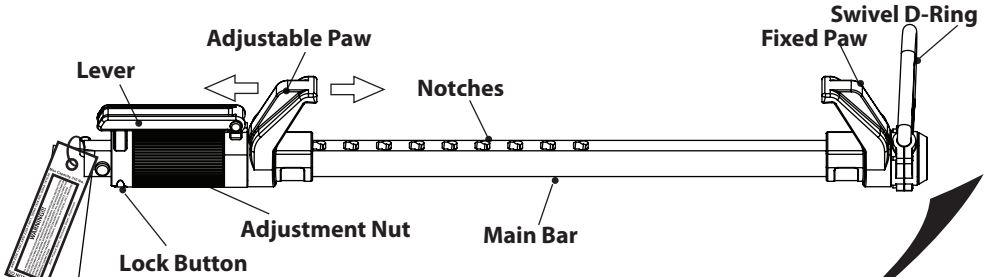

**LABEL LOCATIONS**

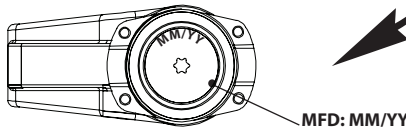

DO NOT REMOVE

Compliance: OSHA 1926.502, OSHA 1910.66, ANSI Z359.18 Type A, ANSI Z359.7(11)  
EN 795:2012 Type B CE 2777

**WARNING:** ALL PERSONS USING THIS EQUIPMENT MUST READ AND UNDERSTAND ALL INSTRUCTIONS. FAILURE TO DO SO MAY RESULT IN SERIOUS INJURY OR DEATH. USERS SHOULD BE FAMILIAR WITH PERTINENT REGULATIONS GOVERNING THIS EQUIPMENT. ALL INDIVIDUALS WHO USE THIS PRODUCT MUST BE PROPERLY INSTRUCTED ON HOW TO USE THE DEVICE. AVOID CONTACT WITH PHYSICAL HAZARDS (THERMAL, CHEMICAL, ELECTRICAL, ETC.). MAKE ONLY COMPATIBLE CONNECTIONS.

Zinc Plated Steel, Stainless Steel, Aluminum

Max Capacity: 310 lbs.  
BREAKING STRENGTH  
5,000 LBF (22kN)

CE 2777

IMAX

**CLIMBTECH**

1-(512) 308-6440

VERTICAL/FIXED BEAM CLAMP  
Model: VBC014N  
Batch #: XX-XXX  
INSPECT BEFORE USE

**LOADING CONDITIONS DIAGRAM**

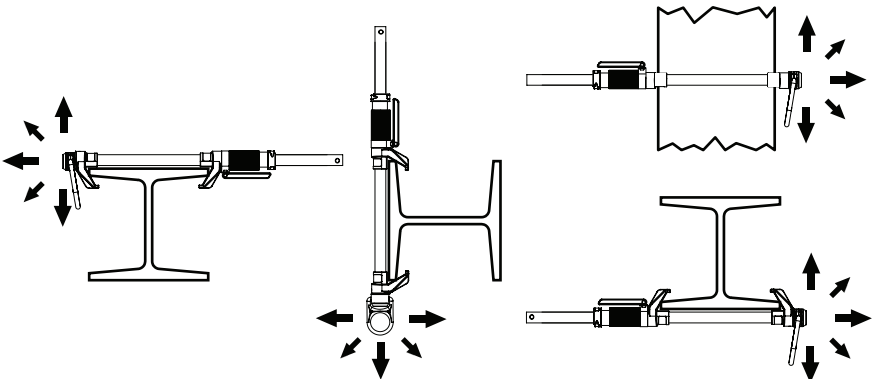

\*Note: Placement at or below a user's working height requires integration of a compatible ANSI Z359.18 Type T shock-absorbing lanyard that does not allow user to extend more than 6 feet (1.8m) (in any direction) from the anchorage connector before shock absorber is activated. Beam anchor must be attached to I-beam flange facing the user (top flange if above, bottom flange if below, etc.).

# INSTALLATION INSTRUCTIONS

**1**

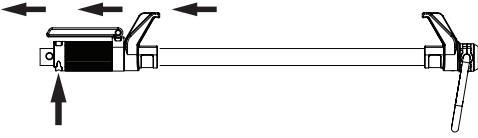

1. Press lock button and slide adjustable paw to widest position.

**2**



2. Fully loosen nut by turning counterclockwise.

**3**

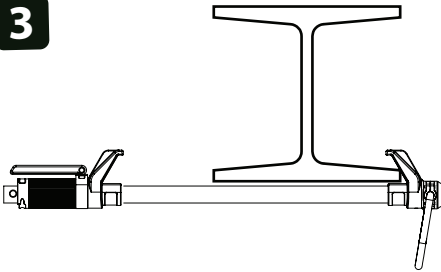

3. Hook fixed paw on far side of I-beam flange.

**4**

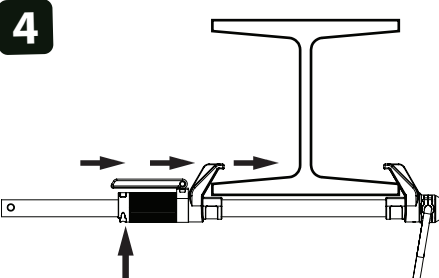

4. Press lock button and slide adjustable paw to tightest notch to capture I-beam flange.

5

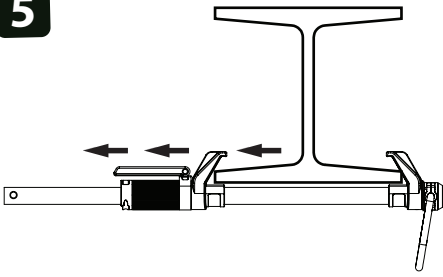

5. Pull back on adjustable paw to ensure it is in a locked position.

6

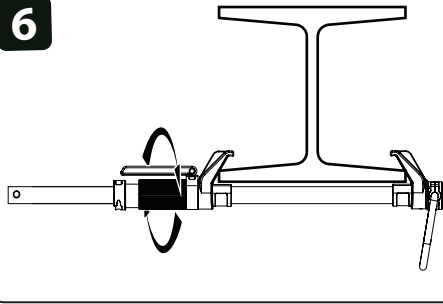

6. Hand tighten nut as much as possible by turning clockwise.

7

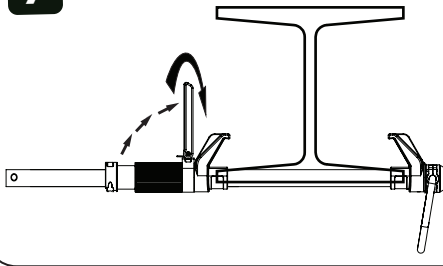

7. Use lever to tighten an extra 1/4 turn.

8

Refer to **“NUT POSITIONS”** diagram to ensure correct installation. If nut position is incorrect, repeat all steps ensuring lock button engages in tightest position during step 4.

### NUT POSITIONS

INCORRECT

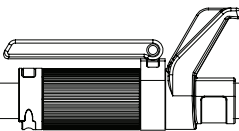

↑  
NO GAP

CORRECT

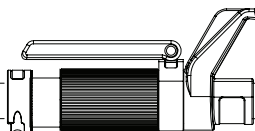

↑ ↑  
GAP

INCORRECT

RED LINE

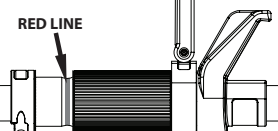

**WARNING:** Use of this product must be approved by an engineer or other qualified person to be compatible with any and all structural & operational characteristics of the selected installation location and system to be connected to this anchorage connector.

**\* SHOCK ABSORBING DEVICE \*  
REQUIRED ABOVE ANCHOR POINT**

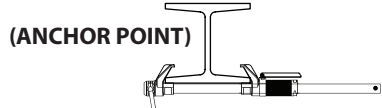
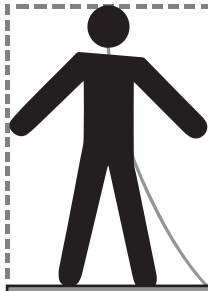

**WORK SURFACE**

**(ANCHOR POINT)**



**WORK SURFACE**

**\*Free fall distance (limit) must  
not exceed 6'ft (1.8 m).**

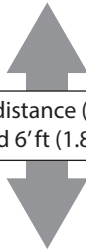

***\*All products subjected to fall arresting  
forces should be removed from service  
immediately!***

**MINIMUM CLEARANCE 3ft (1m)**

**DECK/FLOOR/GROUND LEVEL**

**WARNING!!! SWING FALLS MAY OCCUR WHEN THE WORKER IS NOT DIRECTLY UNDER ANCHOR POINT.**

## MAINTENANCE, CLEANING AND STORAGE

Cleaning periodically will prolong the life and proper functioning of the product. Frequency of cleaning should be determined by inspection and by severity of the environment. Clean with compressed air and/or a stiff brush using plain water or a mild soap and water solution. Do not use any corrosive chemicals that could damage the product. Wipe all surfaces with a clean, dry cloth and hang to dry, or use compressed air. When in transport or not in use, store anchorage connectors in a cool, dry, clean environment, out of direct sunlight and free of corrosive or other degrading elements.

\*It is essential for the safety of the user that if the product is re-sold outside the original country of destination the reseller shall provide instructions for use, maintenance, and for periodic examination and repair in the language of the country in which the product is to be used.

## INSPECTION AND MAINTENANCE LOG

MODEL NUMBER: \_\_\_\_\_

DATE OF MANUFACTURE: \_\_\_\_\_

NAME AND CONTACT DETAILS OF  
THE SUPPLIER OR MANUFACTURER: \_\_\_\_\_

DATE OF PURCHASE: \_\_\_\_\_

DATE OF FIRST USE: \_\_\_\_\_

Date	Part Number	Comments	Inspector Name

### Inspection:

Official periodic inspection must be made at least semi-annually. The inspection must be performed by a qualified person other than the intended user. If severe weather or conditions exist then inspections must be carried out more frequently. All inspection results must be logged in the space provided above. (It is recommended that the anchor device is marked with the date of the next or last inspection.)

1. Make sure all labeling is affixed to the unit.
2. Inspect anchoring system for signs of damage or wear.
3. Make sure the ring is free to swivel and pivot.
4. Ensure button engages and disengages properly.
5. Record inspection results in the space provide above.

**\*If any damage that could affect the strength or operation of the device, or unsafe conditions are found, proper disposal is required. The anchorage connector must be rendered unusable and then properly discarded.**

## **Product Warranty, Limited Remedy and Limitation of Liability**

**WARRANTY: THE FOLLOWING IS MADE IN LIEU OF ALL WARRANTIES OR CONDITIONS, EXPRESS OR IMPLIED, INCLUDING THE IMPLIED WARRANTIES OR CONDITIONS OF MERCHANTABILITY OR FITNESS FOR A PARTICULAR PURPOSE.** Equipment offered by ClimbTech is warranted against factory defects in workmanship and materials for a period of one year from date of purchase or first use by the original owner.

**LIMITED REMEDY:** Upon notice in writing, ClimbTech will repair or replace all defective items at ClimbTech's sole discretion. ClimbTech reserves the right to require that the defective item be returned to its plant for inspection before determining the appropriate course of action. Warranty does not cover equipment damage resulting from wear, abuse, damage in transit, failure to maintain the product or other damage beyond the control of ClimbTech. ClimbTech shall be the sole judge of product condition and warranty options. This warranty applies only to original purchaser and is the only warranty applicable to this product. Please contact ClimbTech technical service department for assistance.

**LIMITATION OF LIABILITY: IN NO EVENT WILL CLIMBTECH BE LIABLE FOR ANY INDIRECT, INCIDENTAL, SPECIAL OR CONSEQUENTIAL DAMAGES INCLUDING, BUT NOT LIMITED TO LOSS OF PROFITS, IN ANY WAY RELATED TO THE PRODUCTS REGARDLESS OF THE LEGAL THEORY ASSERTED.**



**Notified Body responsible for the EC type examination and ongoing conformity:**

**SATRA Technology Europe Ltd.  
Bracetown Business Park  
Clonee  
Dublin D15 YN2P  
Ireland  
Tel: +353 (0)1 437 2484**

**ClimbTech, LLC.  
7303 Bursleson Rd. Suite 901 Austin, TX 78744  
1(512) 308-6440 / [www.climbtech.com](http://www.climbtech.com)**